

# 3D KLIZAČ SA DONJOM MONTAŽOM OTVARANJE NA PRITISAK - PUSH TO OPEN

## PRIMENA

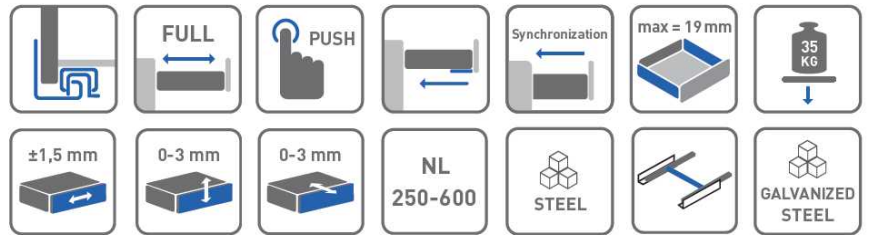

## KARAKTERISTIKE



Upotreba sinhronizatora je obavezna za sve dužine 3D klizača!

## DODATNE INFORMACIJE

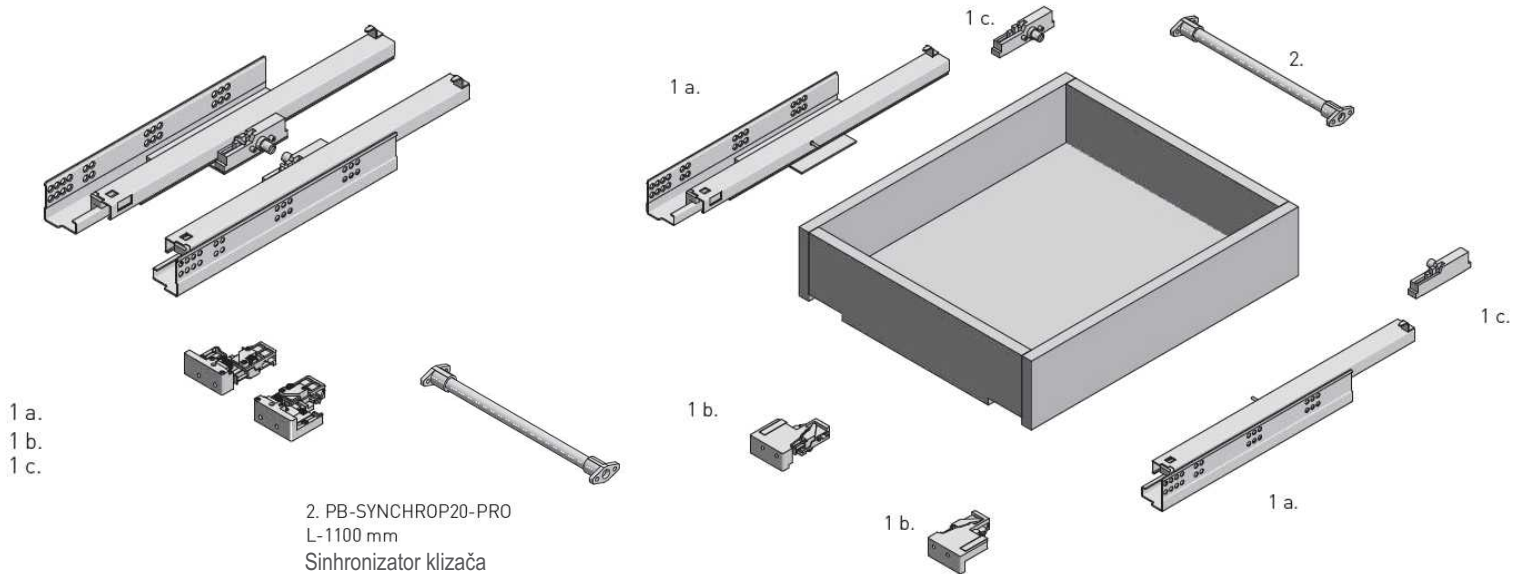

NL mm		AV mm
250	PB-3D0FPO18-250-PRO	5
300	PB-3D0FPO18-300-PRO	-
350	PB-3D0FPO18-350-PRO	-
400	PB-3D0FPO18-400-PRO	-
450	PB-3D0FPO18-450-PRO	-
500	PB-3D0FPO18-500-PRO	-
550	PB-3D0FPO18-550-PRO	-
600	PB-3D0FPO18-600-PRO	-
1100	PB-SYNCHROP20-PRO	-

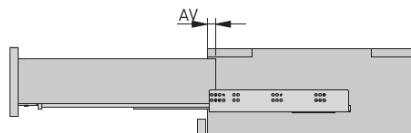

NL = Dužina klizača  
AV = Gubitak kod otvaranja

## NAPOMENA

Za ispravno funkcionisanje klizača,  
širina fioke ne bi smela da prelazi dužinu klizača.

# 3D KLIZAČ SA DONJOM MONTAŽOM OTVARANJE NA PRITISAK - PUSH TO OPEN

## TEHNIČKI PODACI

### Širina fioke

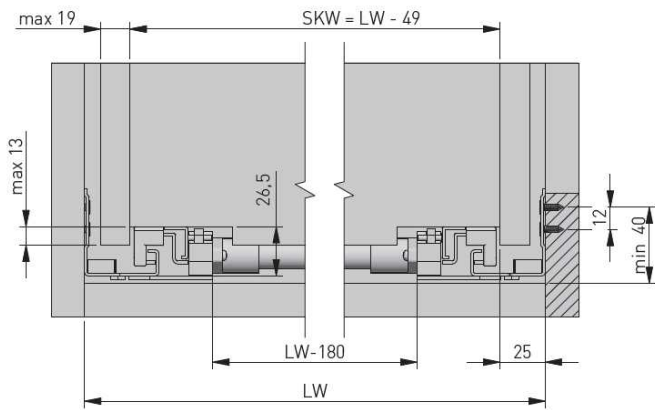

LW - Unutrašnja širina korpusa  
SKW - Unutrašnja širina fioke

### Standardna fioka

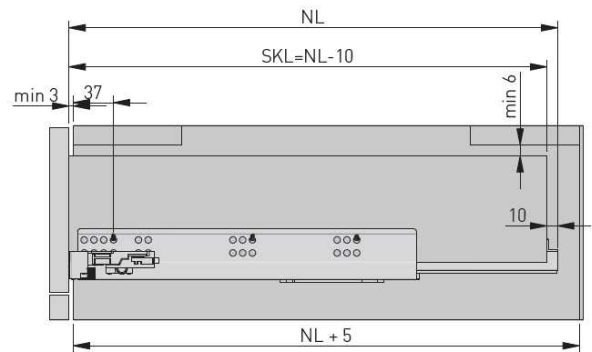

### Unutrašnja fioka

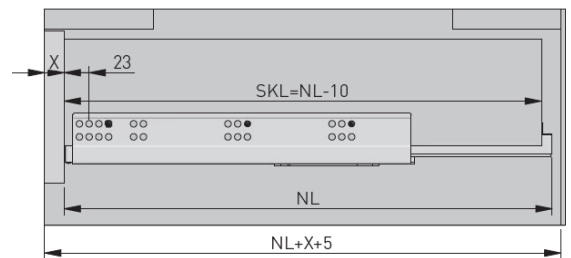

### Dužine klizača:

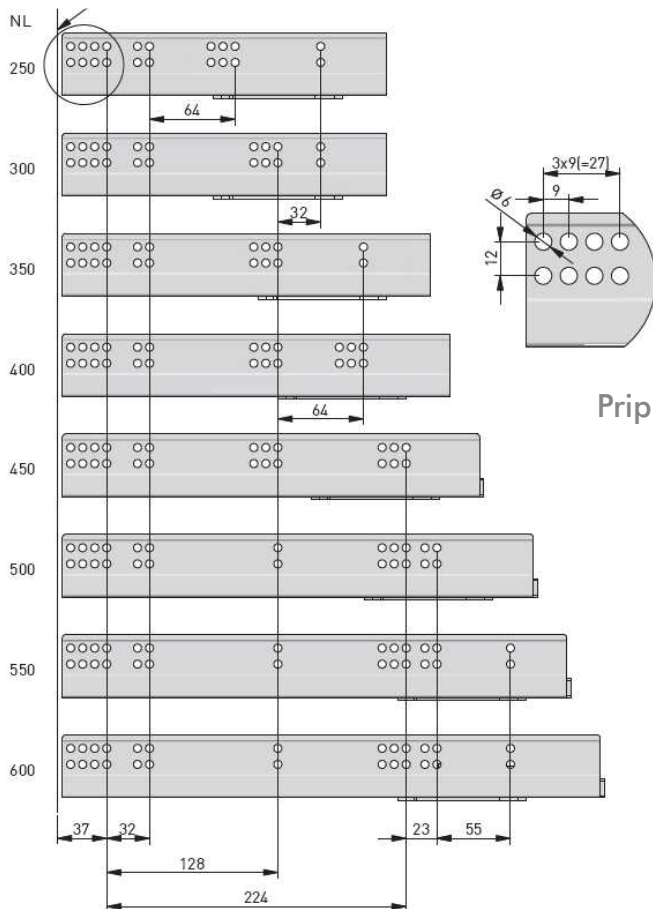

### Priprema klizača

X - Debljina fronta fioke  
SKL - Dubina fioke  
NL - Dužina klizača

